



Benvenuti



Corso Giovani Tiratori 2024



Prima di iniziare: regole base





Programma serata di teoria 2

1. Ripetizione (NF)
2. Bersagli e Marcazione (NF)
3. Posizione a terra (SV)
4. Mira (KM)
5. Correzione (GM)
6. Respirazione (KM)
7. Lo scatto – La partenza del colpo (NF)
8. Svolgimento tiro (SV)
9. Istruzione al test (KM)



1. Ripetizione: appello

Nome	Cognome

Nome	Cognome



1. Ripetizione

- Regole di sicurezza
- Entrata allo stand
- Parti fucile



Ripetizione: regole di sicurezza



- 1. Tutte le armi sono da considerarsi sempre cariche**
- 2. Non puntare un arma verso qualcosa che non si vuole colpire**
- 3. Indice fuori dal ponticello fintanto che il dispositivo di mira non è allineato al bersaglio**
- 4. Essere sicuri del bersaglio**



Ripetizione: prima di entrare allo stand

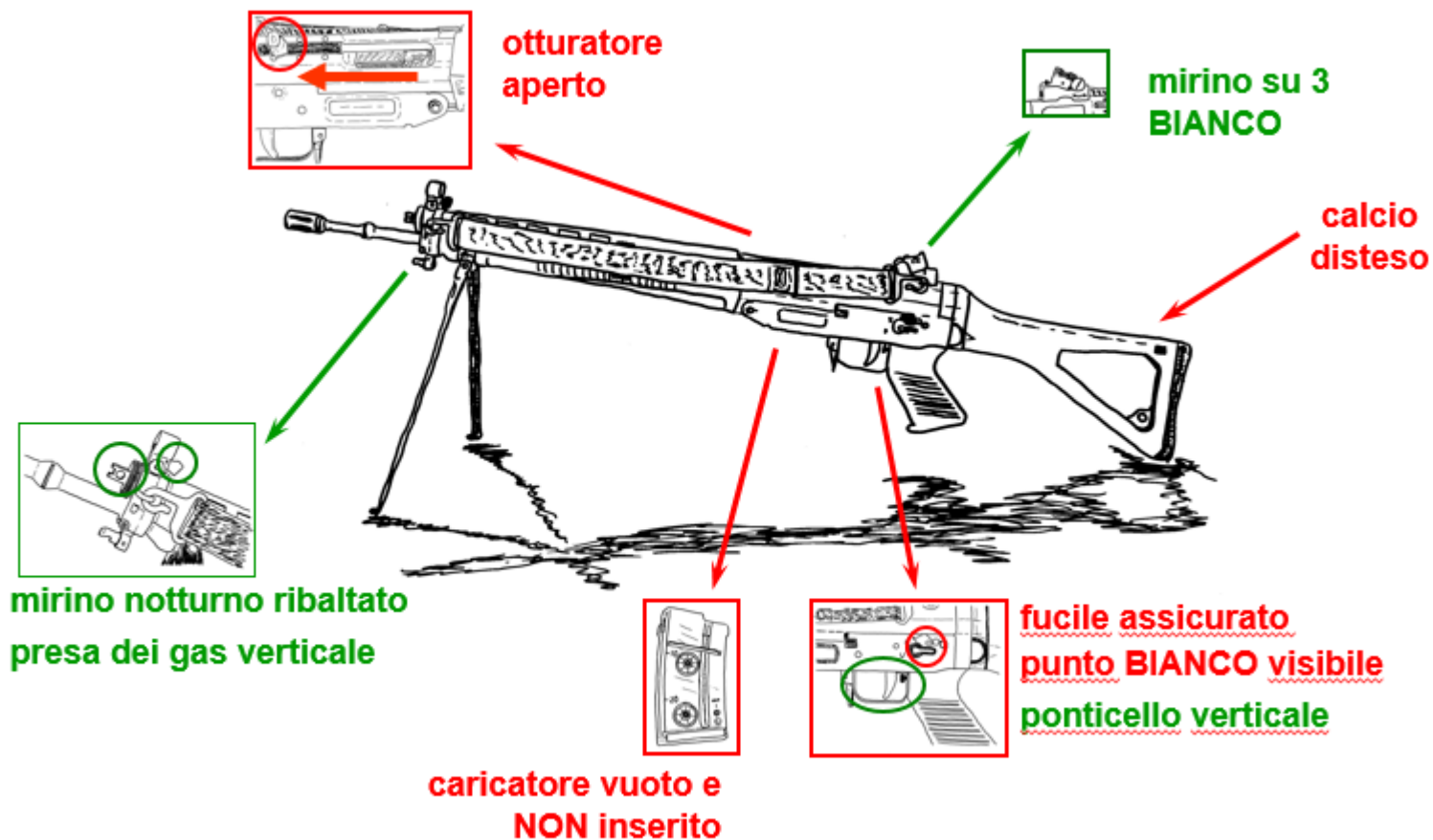



Ripetizione: parti del fucile



1. **Canna**
2. **Gruppo mirino**
3. **Paramano**
4. **Scatola della culatta**
5. **Alzo a diottra**
6. **Calcio**
7. **Impugnatura a pistola**
8. **Scatola dello scatto**
9. **Caricatore**
10. **Bretella**
11. **Bipiede**



Nota: i vostri caricatori hanno una capacità di 20 colpi



2. Bersagli e marcazione

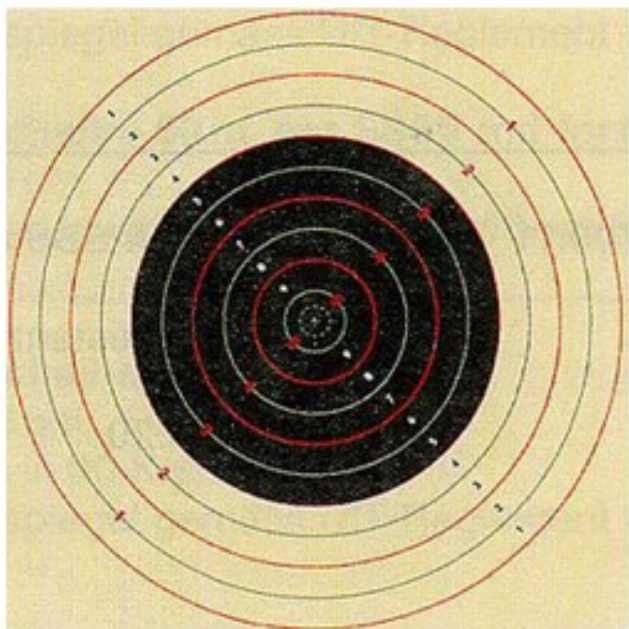

A-Combinato

∅ 100 cm

∅ 60 cm (nero)

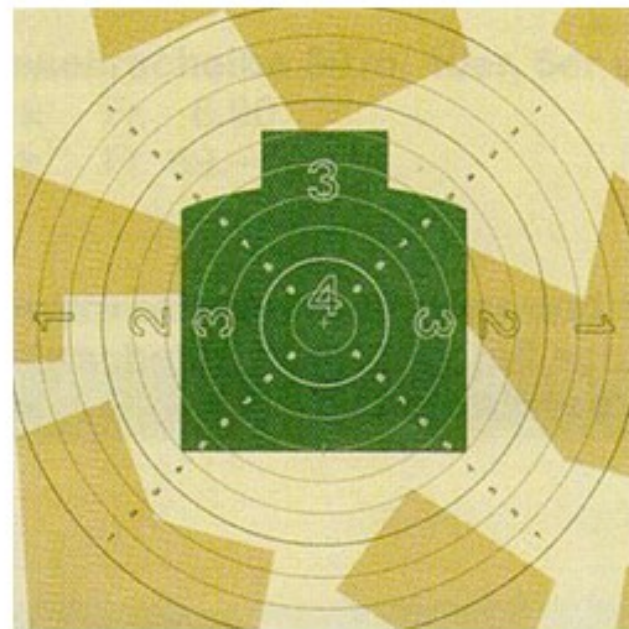

B-Combinato

∅ 100 cm

∅ 45x50 cm (figura)



I bersagli: A - Combinato

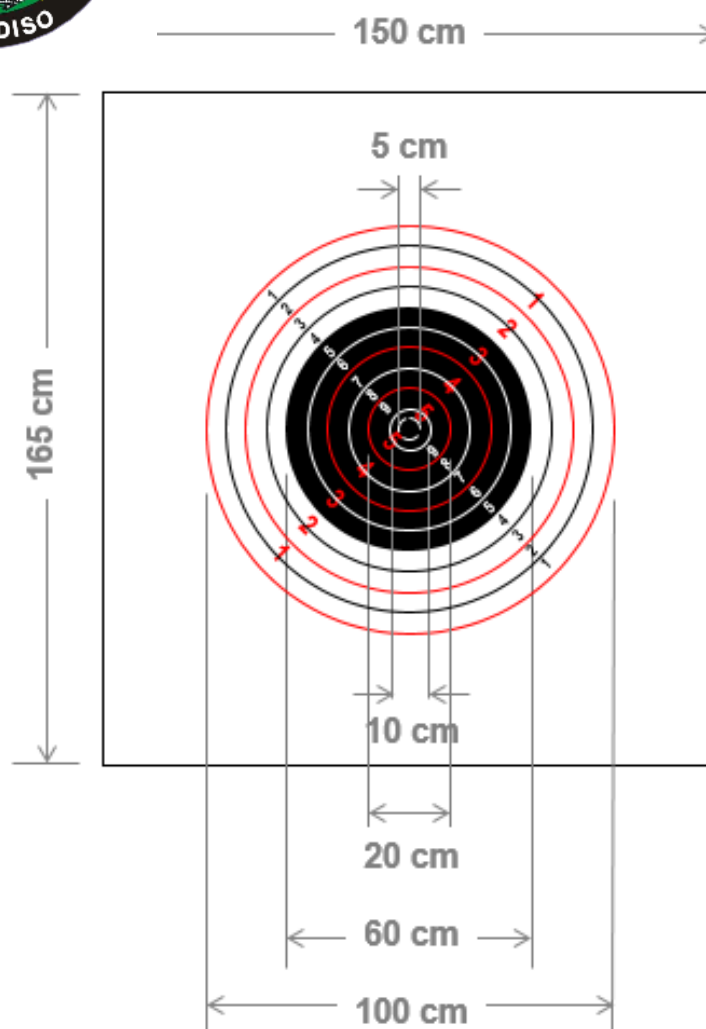

Misure Base

- Ø esterno: 100 cm
- Ø nero: 60 cm
- Ø mouche: 5 cm

Marcazione A 5

- 5 cerchi equidistanti con punti da 1 a 5
- Ø centro (5 punti): 20 cm

Marcazione A 10

- 10 cerchi equidistanti con punti da 1 a 10
- Ø centro (10 punti): 10 cm

Marcazione A 100

- 100 cerchi equidistanti con punti da 1 a 100
- Ø centro (100 punti): 0.5 cm



I bersagli: B - Combinato

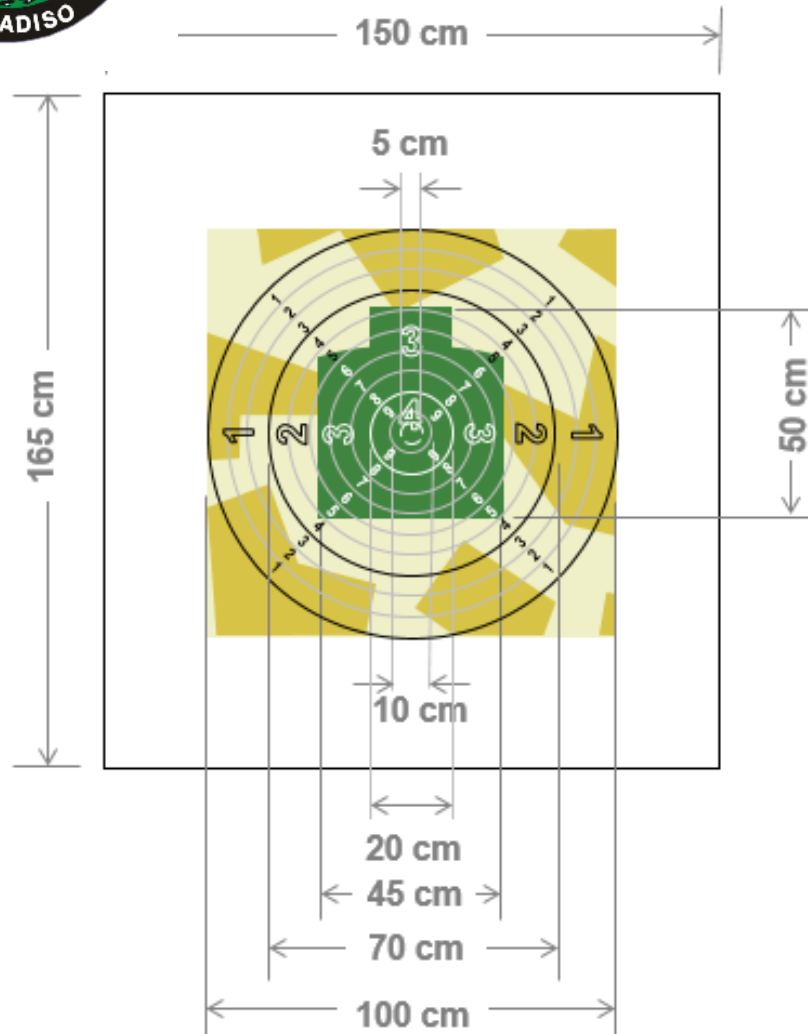

Misure Base

- Quadrato con cerchio iscritto: 100x100 cm
- figura: 45x50 cm
- Ø mouche: 5 cm

Marcazione B 4

- 4 zone con punti da 1 a 4
- Ø centro (4 punti): 20 cm

Marcazione B 10

- 10 cerchi equidistanti con punti da 1 a 10
- Ø centro (10 punti): 10 cm

Marcazione B 100

- 100 cerchi equidistanti con punti da 1 a 100
- Ø centro (100 punti): 0.5 cm



La marcazione

- Elettronica
- Manuale (non trattata)



Marcazione elettronica: funzionamento

6. Il colpito è marcato sul monitor e stampato sul foglio di stand.

Stampante

Monitor



1. Il sensore rileva lo sparo.



5. Dai tempi di reazione dei sensori e dalla velocità del suono si ricava la posizione (triangolazione).

Centralina alla Butte

4. L'onda sonora provocata è rilevata dai sensori.

3. Il proiettile buca il bersaglio.

2. Al bersaglio si misura l'attuale velocità del suono nell'aria.

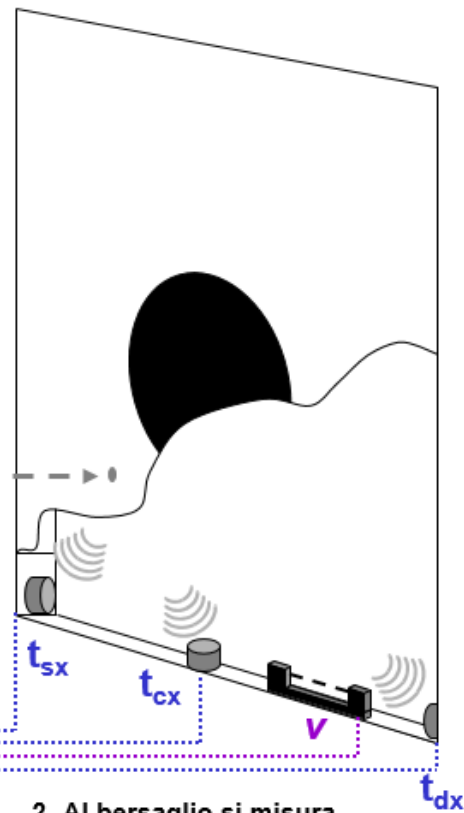



Marcazione elettronica: monitor

Bersaglio con 1 colpiti

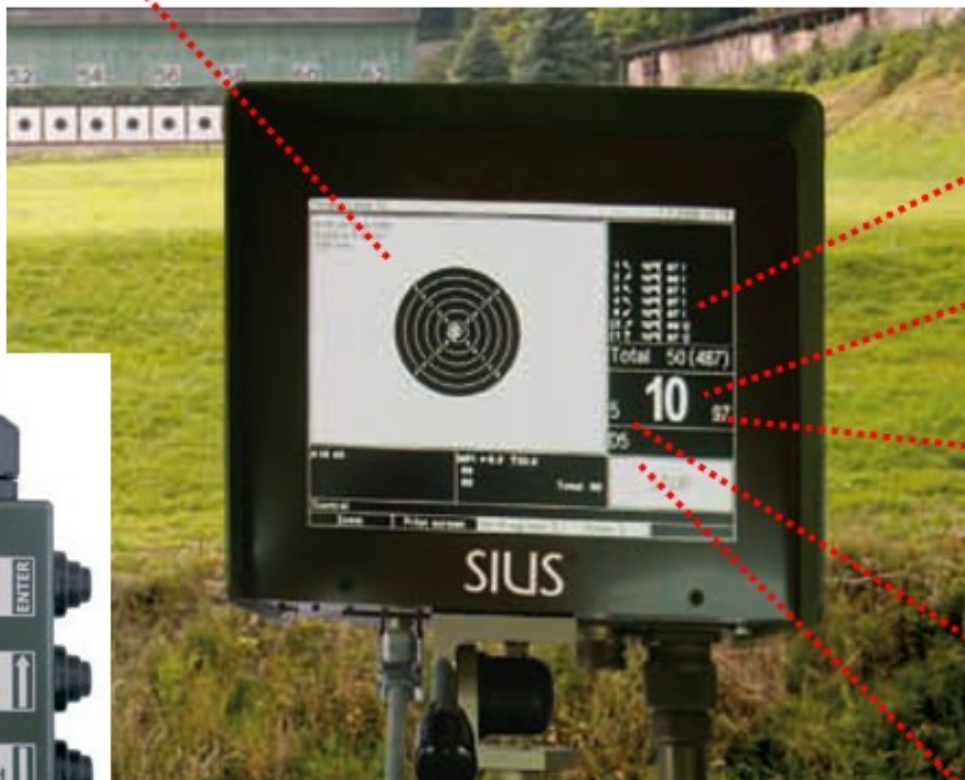

Colpiti precedenti

Valore del colpo

Marcazione centesimale
($\frac{1}{2}$ centimetri dal bordo esterno)

Numero progressivo
del colpo

Programma



Telecomando



Marcazione elettronica: unità di controllo

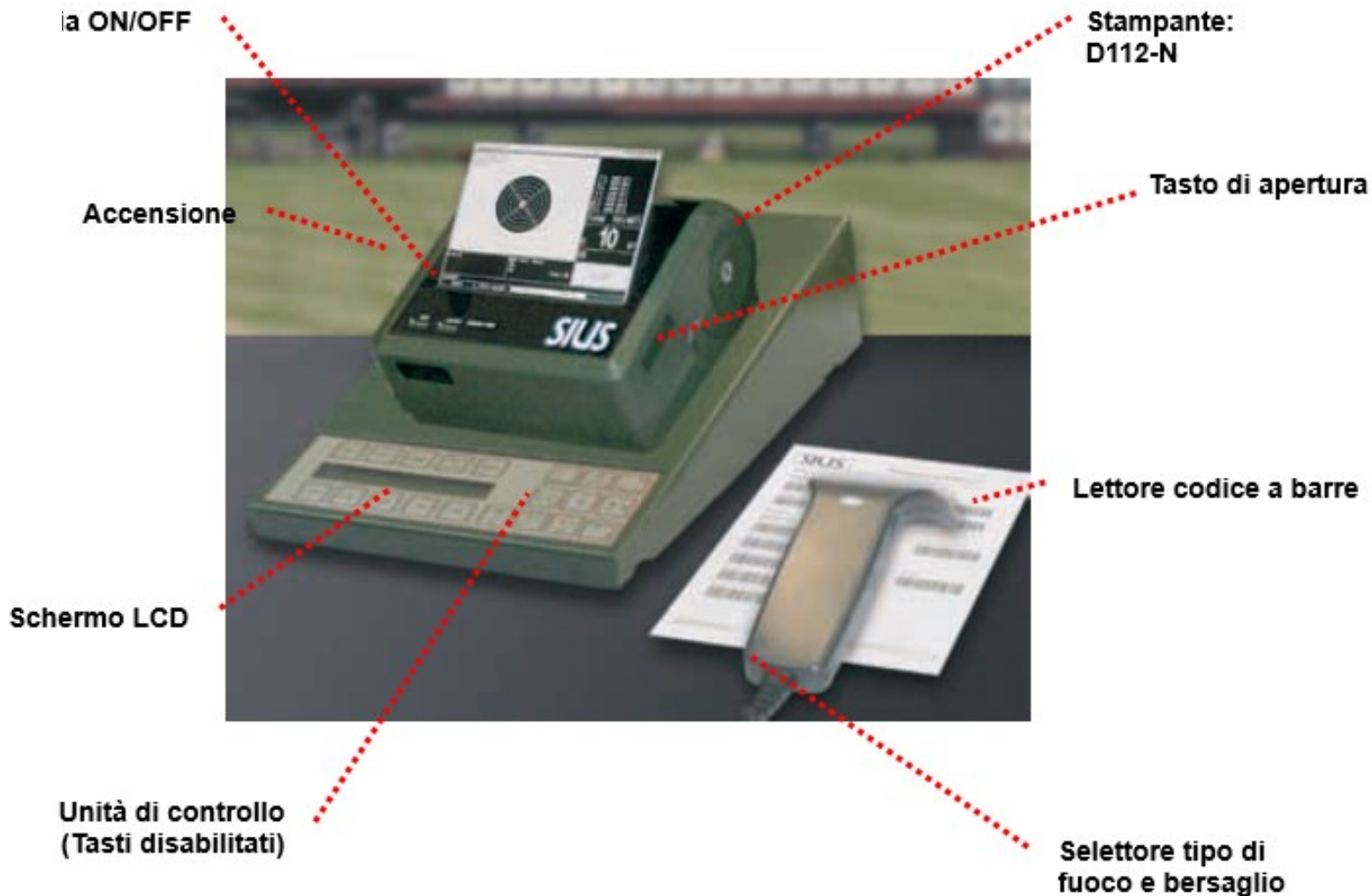



Marcazione elettronica: domande





3. La posizione a terra

- Posizione centrale
- Posizione laterale



La posizione a terra: centrale

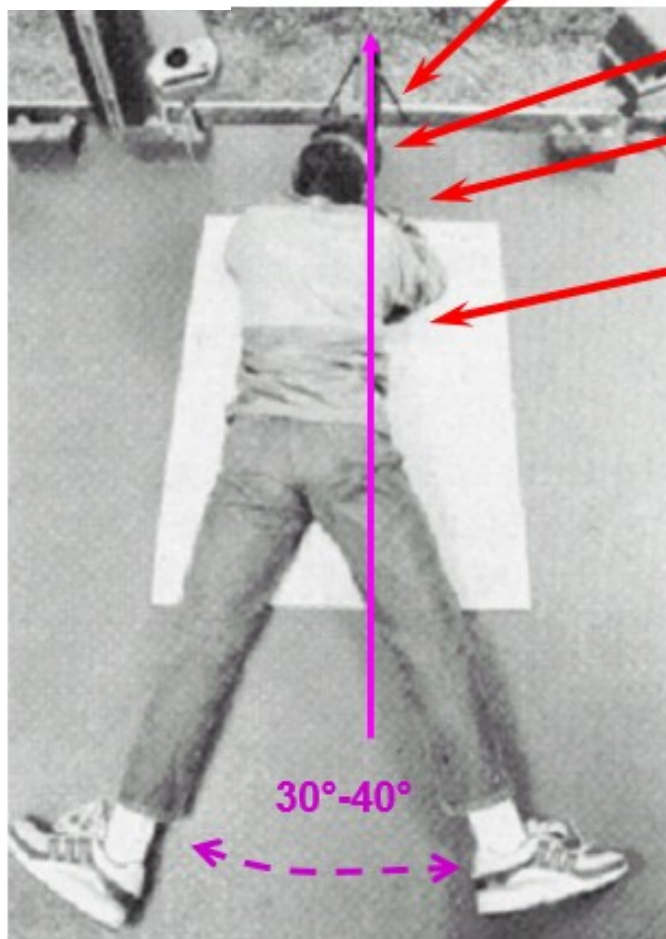

• Bipiede dritto

• 8-12 cm tra occhio e diottra

• La mano debole tiene il Fass appoggiato alla spalla

• La mano forte afferra omogeneamente l'impugnatura

• La distanza tra i gomiti dipende dallo stand



La posizione a terra: laterale

15°-35°

- La mano debole tiene il Fass appoggiato alla spalla
- La mano forte afferra omogeneamente l'impugnatura

• 8-12 cm tra occhio e diottra

- Gomito debole avanzato
- La distanza tra i gomiti dipende dallo stand

• Bipiede dritto

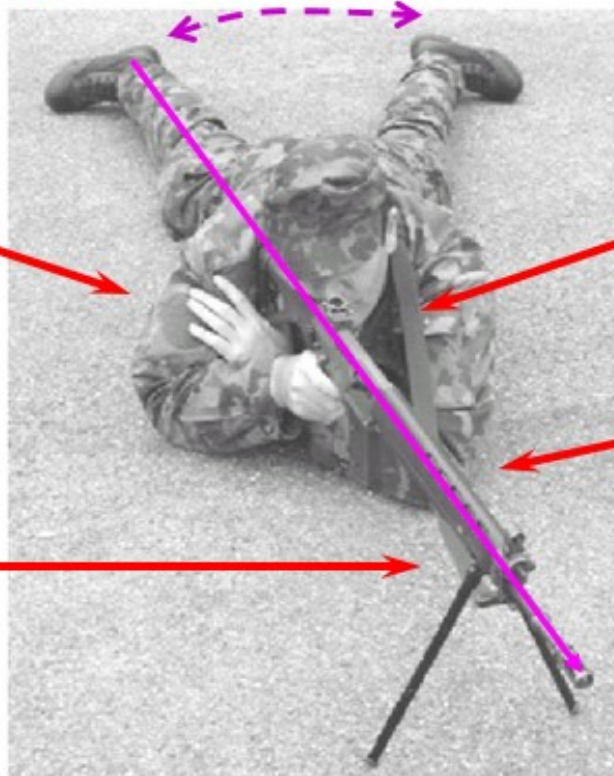



La posizione a terra: domande





3. Mira

- Linea di tiro e linea di mira
- Immagine di mira



Linea di tiro e linea di mira



Diottra



Mirino

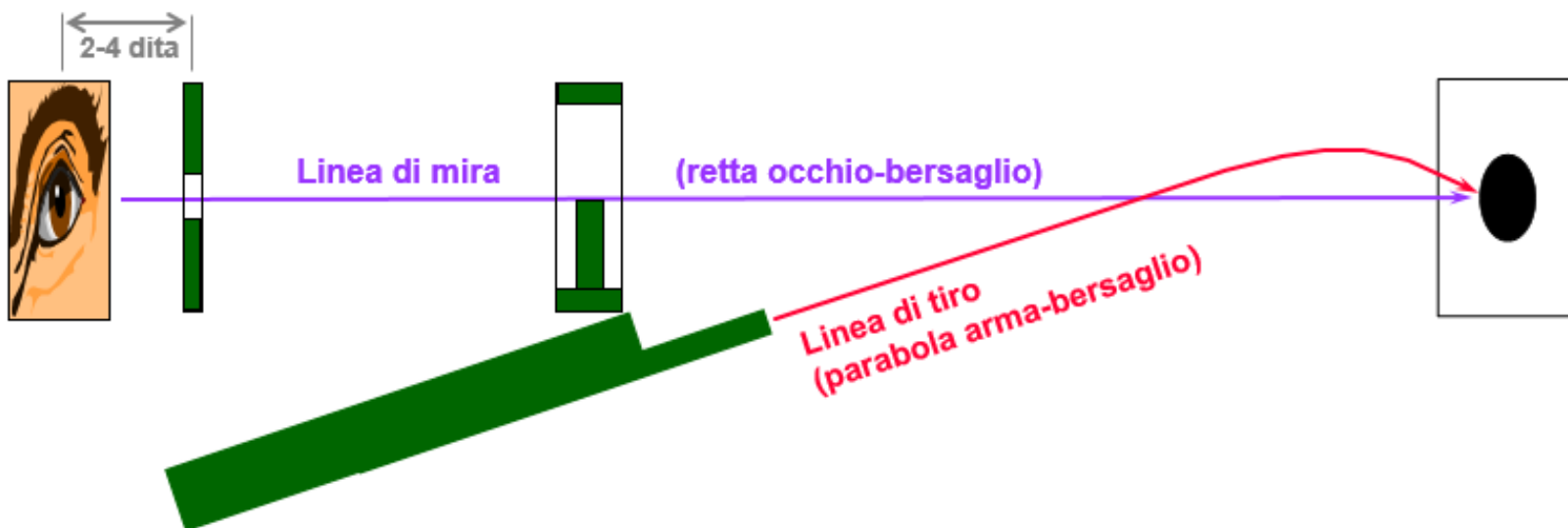

Tramite mirino e diottra il fucile viene allineato sul bersaglio.



Immagine di mira





Cosa mettere a fuoco

Errore

→ Non si possono mettere a fuoco punti a distanza diversa !

→ L'errore minore si ha con a fuoco il mirino !

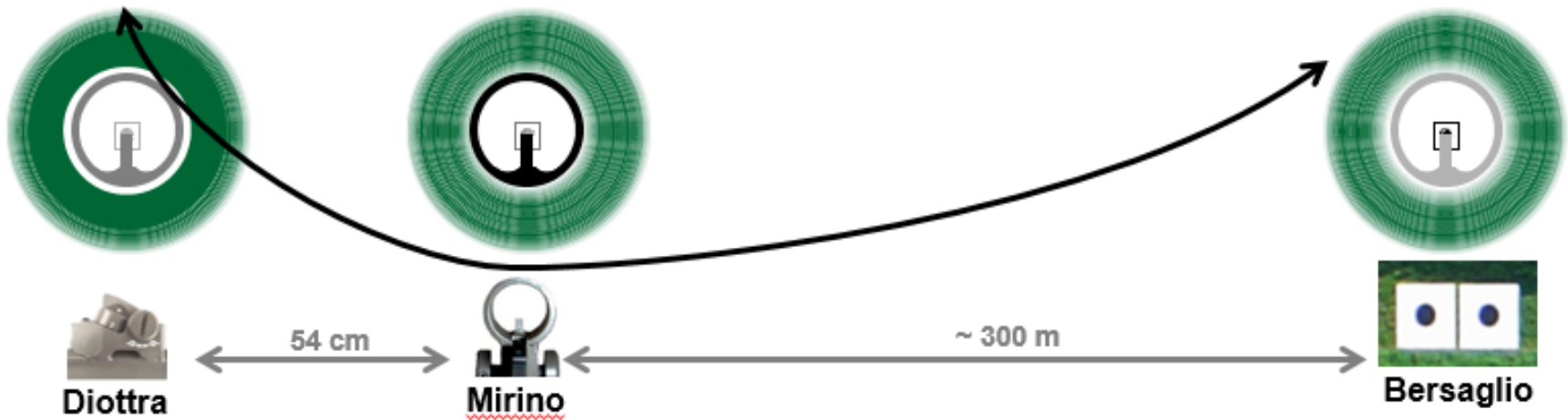



Nero 6 vs Nero «centro»





Mira: domande





5 minuti di PAUSA

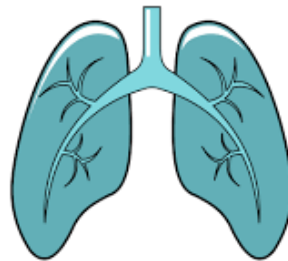



4. Correzione

- Quando correggere
- Come correggere



Correzione: tre colpi di prova

Memorizzare i colpi:
punti e posizione

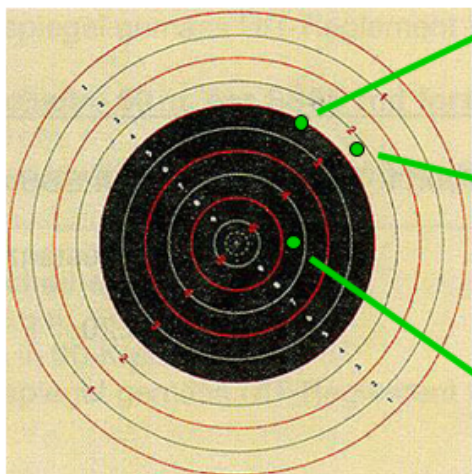



Correzione: definire il colpito medio

Stimare punteggio e posizione

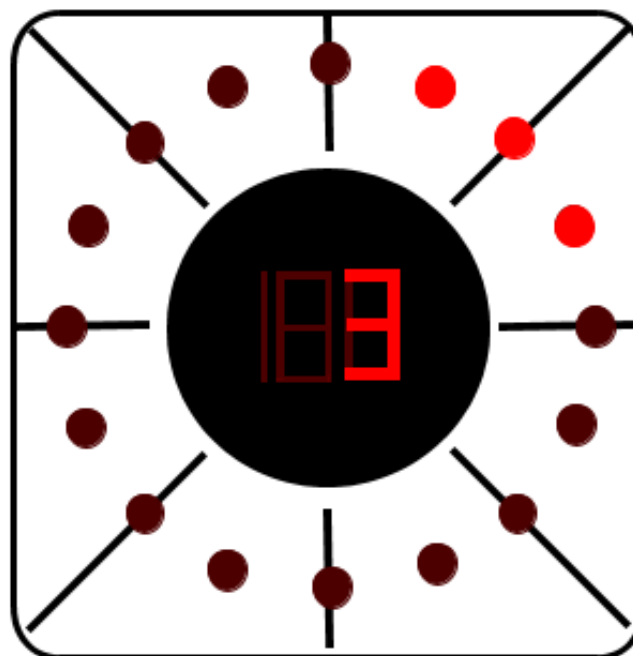
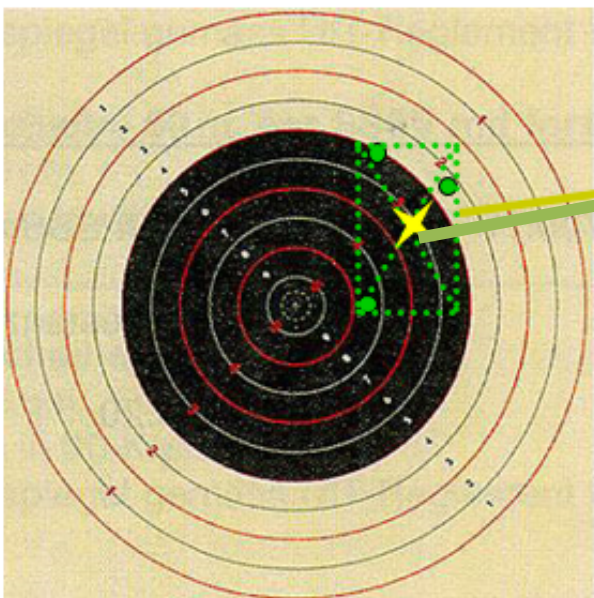



Correzione: quando farla

**Rosata piccola,
correzione
efficace.**

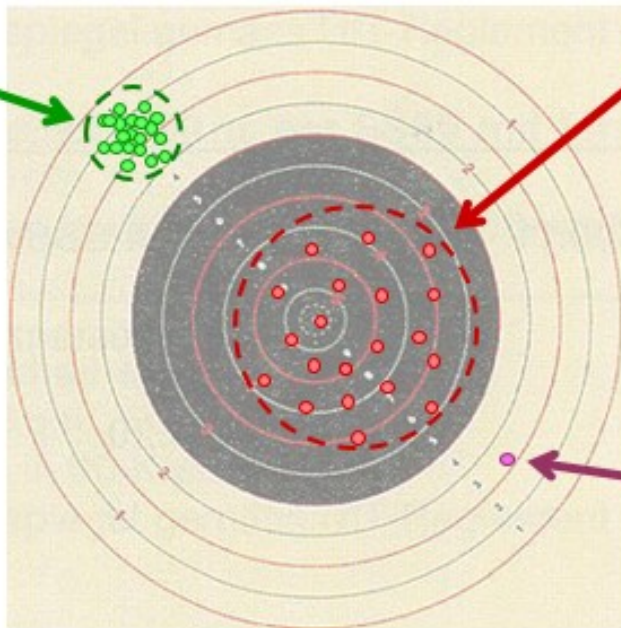

**Rosata larga e centrale,
correzione poco utile.**

Il problema è altrove !

**Valore estremo,
poco significativo.**

Errore puntuale !

Occorre correggere per compensare:

- Assestamenti della posizione
- Spostamenti del fucile
- Luce e vento



Correzione: stimare le tacche

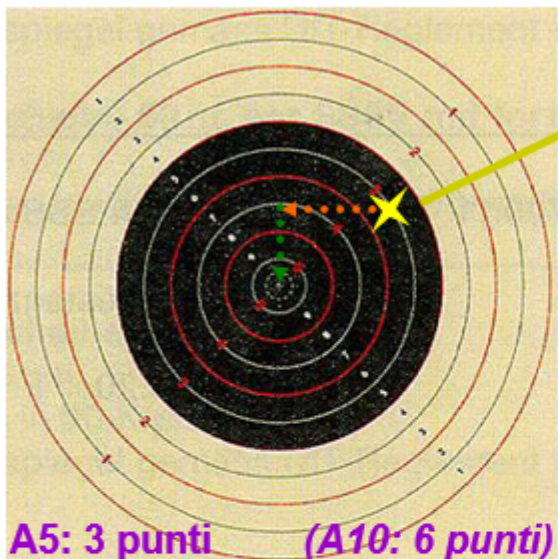

183

$$\Rightarrow Tacche_{A5} = \frac{3 \rightarrow 4 \rightarrow 5}{\times 2} \rightarrow 2 \rightarrow 4$$

$$\Rightarrow Tacche_{A10} = \frac{6 \rightarrow 7 \rightarrow 8 \rightarrow 9 \rightarrow 10}{\times 2} \rightarrow 4$$

A5: 3 punti (A10: 6 punti)

- Contare i punti per arrivare al centro del bersaglio
- Se su A5/B4 radoppiare il numero



1 tacca = 4.5 cm:
 → 1 tacca su A5/B4 = circa 1/2 punto
 → 1 tacca su A10/B10 = circa 1 punto



Correzione: esecuzione

Eeguire la correzione

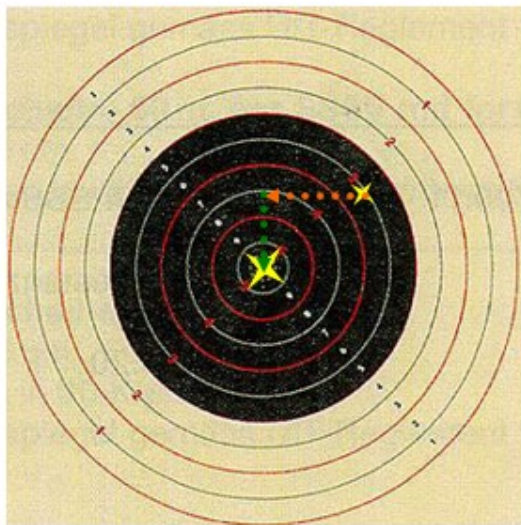

4 in giù

4 a sinistra

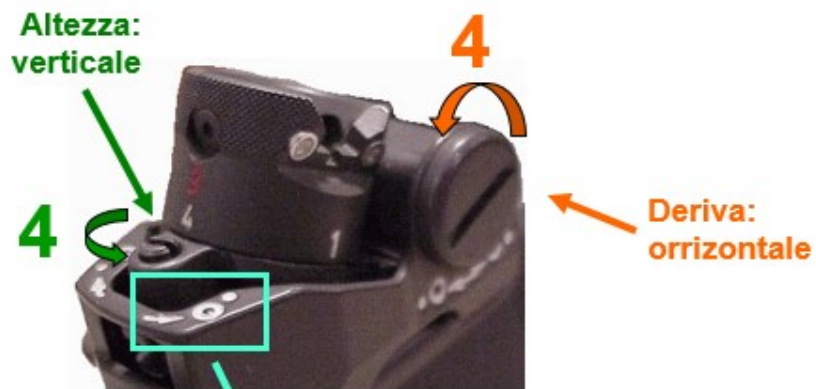

Direzione
(freccetta)

Colpito
(punto)



Bersaglio
(ciambella)

Per correggere:

- Si gira verso il colpito
- 1 tacca = 4.5 cm a 300 m



Correzione: domande





5. Respirazione

- Respirare
- Sequenza nella respirazione



Respirazione corretta

Respirazione corretta:

- **Diaframmatica: con la pancia**
- **Regolare**
- **Lenta**
- **Profonda**



Vantaggi:

- **Migliore ossigenazione dei tessuti**
- **Riduzione delle pulsazioni**
- **Riduzione di agitazione e ansia**
- **Facilita la concentrazione**



Respirazione: sequenza

Principio base: quando si tira non si respira

Sequenza:

- Inspirare, Espirare, Inspirare, poi Espirare completamente
- Trattenere il respiro al massimo per max 3-5 secondi
- Se si è pronti, far partire il colpo (altrimenti riprendere la respirazione)
- Dopo la partenza del colpo trattenere ancora un attimo il fiato

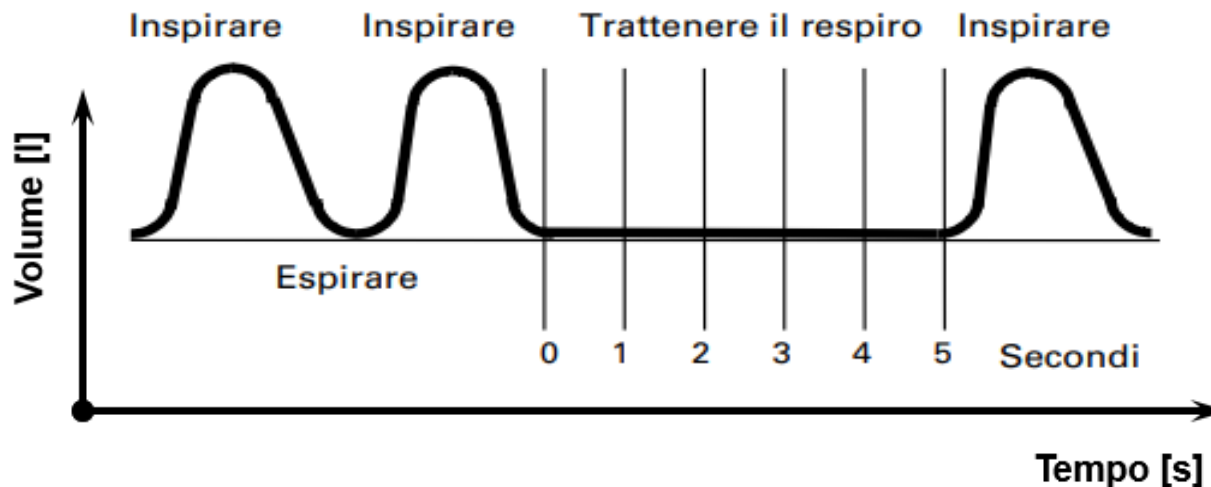



Respirazione: domande





7. Lo scatto – la partenza del colpo

- Corsa e punto d'arresto
- Come tirare il grilletto
- La partenza coordinata del colpo



Corsa e punto di arresto

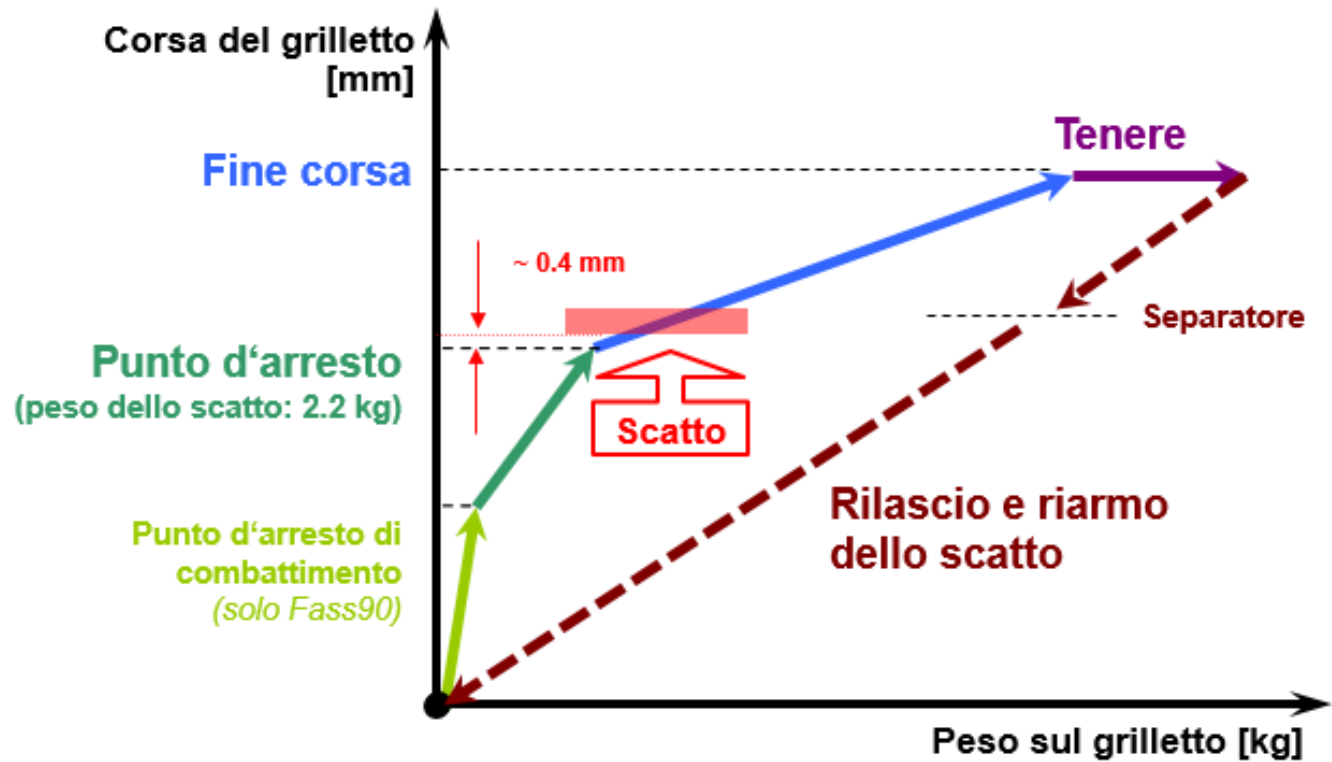

peso dello scatto	[kg]
Fass90	2.2
Fass57	4.0
Mo31, F89/11	1.3
Fucile Standard ISSF	1.5
Fucile ISSF	libero



Come tirare il grilletto

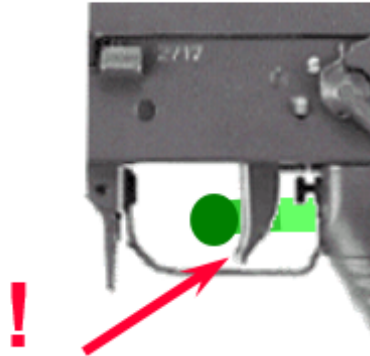

Prendere il grilletto alla piegatura

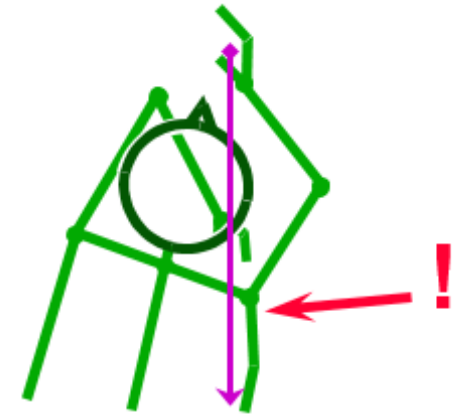

Tirare in linea con il fucile e la spalla



Stringere la mano all'impugnatura



La partenza coordinata del colpo: l'attenzione

Importanza di una posizione 0 stabile.

Importanza di una
immagine di mira
corretta.

Muscoli e
posizione
del corpo



Immagine di
mira



Importanza di
uno scatto
fluida e
regolare.

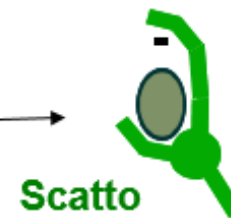

Attenzione
relativa
100%

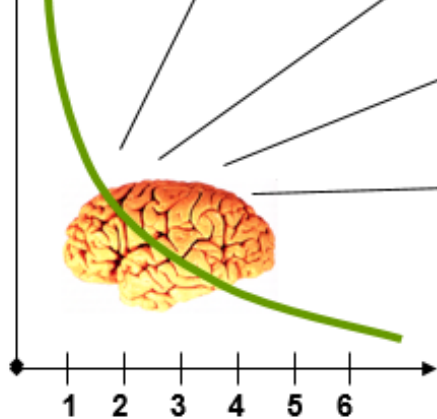

Argomenti sui quali il
cervello si concentra



La partenza coordinata del colpo: la sequenza

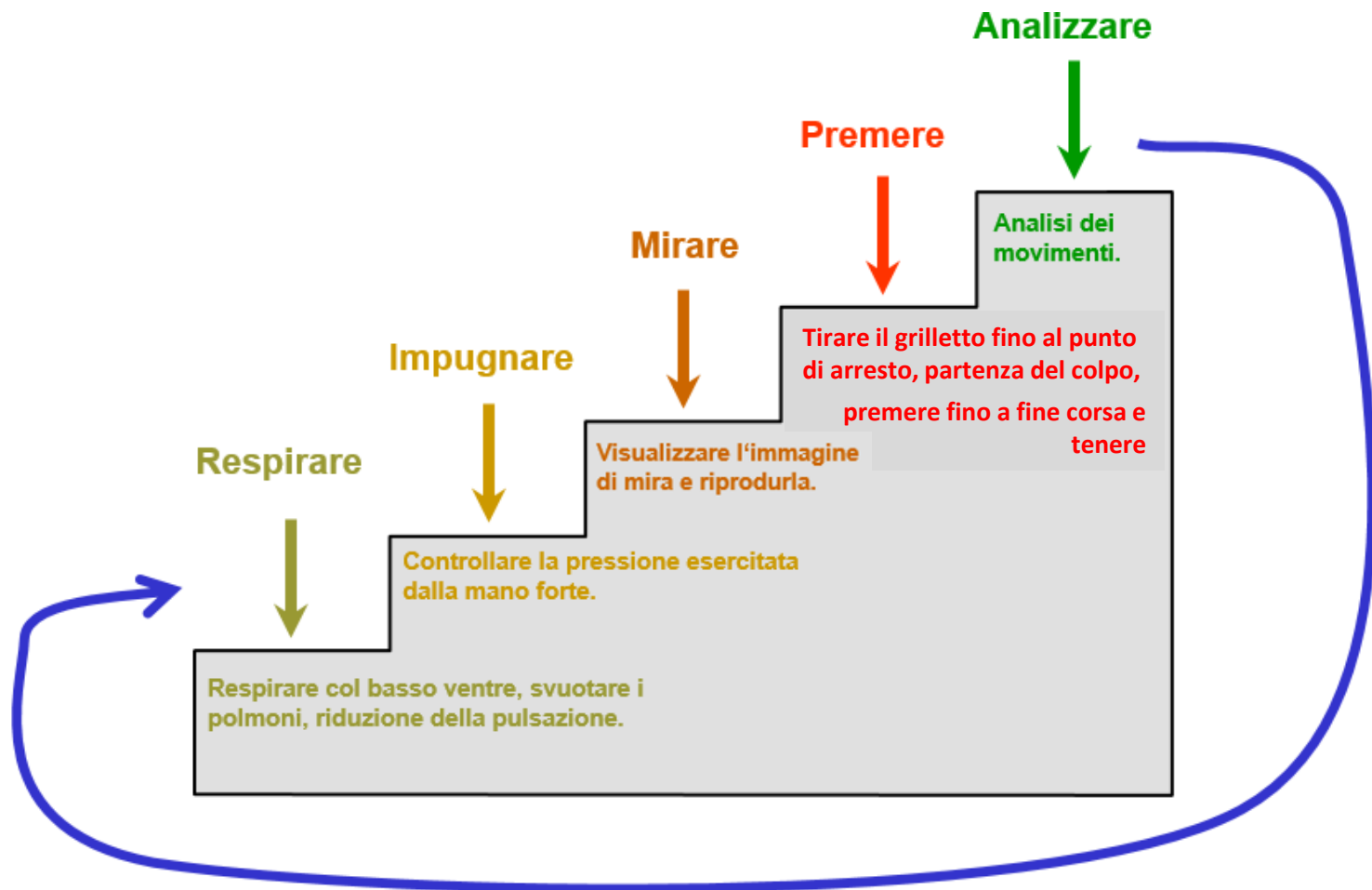



Domande





7. Svolgimento del tiro

- Giornata di tiro
- Fogli di stand
- Equipaggiamento



Giornata di tiro

1. Preparazione



Divisione in classi.

2. Teoria / Tiro

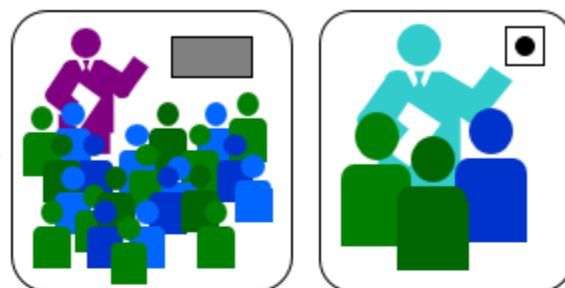

Si alternano momenti di teoria ad esercizi di tiro

3. Discussione e SP



Chiusura

4. Congedo





Fogli di stand

Foglio di stand Giovani Tiratori		Corso 1	Corso 2	Anno	N°
Cognome, Nome		N° AFS			
Data di nascita		N° Fass			
1° Giorno di tiro, tiro d'istruzione					
3 x 1 colpo, tiro d'aggiustamento, A5	<input type="text"/>	<input type="text"/>	<input type="text"/>	<input type="text"/>	<input type="text"/>
3 x 3 colpi, colpo per colpo, A5 - Conzioni solo dopo 3 colpi	<input type="text"/>	<input type="text"/>	<input type="text"/>	<input type="text"/>	<input type="text"/>
5 x 1 colpo, colpo per colpo, A5	<input type="text"/>	<input type="text"/>	<input type="text"/>	<input type="text"/>	<input type="text"/>
compilare a mano o incollare qui la striscia				<input type="text"/>	<input type="text"/>
2° Giorno di tiro, tiro d'istruzione					
2 x 1 colpo, tiro d'aggiustamento, A5	<input type="text"/>	<input type="text"/>	<input type="text"/>	<input type="text"/>	<input type="text"/>
5 x 1 colpo, colpo per colpo, A5	<input type="text"/>	<input type="text"/>	<input type="text"/>	<input type="text"/>	<input type="text"/>
1 x 3 colpi, fuoco rapido, A5	<input type="text"/>	<input type="text"/>	<input type="text"/>	<input type="text"/>	<input type="text"/>
compilare a mano o incollare qui la striscia				<input type="text"/>	<input type="text"/>
3° Giorno di tiro, tiro d'istruzione					
2 x 1 colpo, tiro d'aggiustamento, B4	<input type="text"/>	<input type="text"/>	<input type="text"/>	<input type="text"/>	<input type="text"/>
2 x 3 colpi, colpo per colpo, B4	<input type="text"/>	<input type="text"/>	<input type="text"/>	<input type="text"/>	<input type="text"/>
2 x 3 colpi, fuoco rapido, B4	<input type="text"/>	<input type="text"/>	<input type="text"/>	<input type="text"/>	<input type="text"/>
1 x 6 colpi, fuoco rapido, B4	<input type="text"/>	<input type="text"/>	<input type="text"/>	<input type="text"/>	<input type="text"/>
compilare a mano o incollare qui la striscia				<input type="text"/>	<input type="text"/>
4° Giorno di tiro, tiro di precisione					
2 x 1 colpo, tiro d'aggiustamento, A10	<input type="text"/>	<input type="text"/>	<input type="text"/>	<input type="text"/>	<input type="text"/>
5 x 1 colpo, colpo per colpo, A10	<input type="text"/>	<input type="text"/>	<input type="text"/>	<input type="text"/>	<input type="text"/>
1 x 4 colpi, fuoco rapido, A10	<input type="text"/>	<input type="text"/>	<input type="text"/>	<input type="text"/>	<input type="text"/>
compilare a mano o incollare qui la striscia				<input type="text"/>	<input type="text"/>

5° Giorno di tiro, tiro principale																																																	
3 x 1 colpo, tiro d'aggiustamento, A10	<input type="text"/>																																																
10 x 1 colpo, colpo per colpo, A10	<input type="text"/>																																																
1 x 5 colpi, fuoco rapido, A10	<input type="text"/>																																																
compilare a mano o incollare qui la striscia																																																	
Il corso è considerato riuscito al momento che tutti i programmi di cui sopra sono stati tirati e i risultati inseriti nel ASF in partecipanti Corso GT.																																																	
Tiro di concorso, Corso 1+2																																																	
Il tiro di concorso può essere effettuato solamente se i programmi di cui sopra sono stati tutti tirati e può essere tirato sul proprio stand solo se non si partecipa alla GCant 300m. Il risultato va in ogni caso poi inserito nel AFS in partecipanti Corso GT.																																																	
3 x 1 colpo, tiro d'aggiustamento, A10	<input type="text"/>																																																
5 x 1 colpo, colpo per colpo, A10	<input type="text"/>																																																
1 x 4 colpi, fuoco rapido, A10	<input type="text"/>																																																
Distribuzione di corone da punti: 1° Corso: 75 2° Corso: 75																																																	
compilare a mano o incollare qui la striscia																																																	
Firma del segretario																																																	
Tiri Militari																																																	
PO e TFC vanno eseguiti sul foglio di stand dedicato, il cui numero di controllo deve corrispondere a quello di questo foglio. I fogli di stand di TO e TFC vanno allegati a questo foglio, i risultati vanno inseriti nel AFS in partecipanti Corso GT.																																																	
	Risultato PO <input type="text"/> Menzione onorevole da punti: U17: 63 U21: 64																																																
	Risultato TFC <input type="text"/> Menzione onorevole da punti: U17: 52 U21: 53																																																
Distribuzione di corone da punti: U17: 54 U21: 55 o 18 colpi in figura																																																	
È conseguita con entrambe le seguenti due condizioni minime rispettate e se richieste per tramite dell'apposito formulario (27.122 gS).																																																	
Distinzione Militare di Tiro																																																	
Programma Obbligatorio 72 punti, senza 0																																																	
Tiro Federale in Campagna 60 punti, senza 0																																																	
Test																																																	
<table border="1"> <tr> <td>Test #</td> <td>1</td><td>2</td><td>3</td><td>4</td><td>5</td><td>6</td><td>7</td><td>8</td><td>9</td><td>10</td><td>11</td><td>12</td><td>13</td><td>14</td><td>15</td> </tr> <tr> <td>Concorso Individuale</td> <td><input type="text"/></td><td><input type="text"/></td><td><input type="text"/></td><td><input type="text"/></td><td><input type="text"/></td><td><input type="text"/></td><td><input type="text"/></td><td><input type="text"/></td><td><input type="text"/></td><td><input type="text"/></td><td><input type="text"/></td><td><input type="text"/></td><td><input type="text"/></td><td><input type="text"/></td><td><input type="text"/></td> </tr> <tr> <td>Concorso Militare</td> <td><input type="text"/></td><td><input type="text"/></td><td><input type="text"/></td><td><input type="text"/></td><td><input type="text"/></td><td><input type="text"/></td><td><input type="text"/></td><td><input type="text"/></td><td><input type="text"/></td><td><input type="text"/></td><td><input type="text"/></td><td><input type="text"/></td><td><input type="text"/></td><td><input type="text"/></td><td><input type="text"/></td> </tr> </table>	Test #	1	2	3	4	5	6	7	8	9	10	11	12	13	14	15	Concorso Individuale	<input type="text"/>	<input type="text"/>	<input type="text"/>	<input type="text"/>	<input type="text"/>	<input type="text"/>	<input type="text"/>	<input type="text"/>	<input type="text"/>	<input type="text"/>	<input type="text"/>	<input type="text"/>	<input type="text"/>	<input type="text"/>	<input type="text"/>	Concorso Militare	<input type="text"/>	<input type="text"/>	<input type="text"/>	<input type="text"/>	<input type="text"/>	<input type="text"/>	<input type="text"/>	<input type="text"/>	<input type="text"/>	<input type="text"/>	<input type="text"/>	<input type="text"/>	<input type="text"/>	<input type="text"/>	<input type="text"/>	Totale: ___ / 15
Test #	1	2	3	4	5	6	7	8	9	10	11	12	13	14	15																																		
Concorso Individuale	<input type="text"/>	<input type="text"/>	<input type="text"/>	<input type="text"/>	<input type="text"/>	<input type="text"/>	<input type="text"/>	<input type="text"/>	<input type="text"/>	<input type="text"/>	<input type="text"/>	<input type="text"/>	<input type="text"/>	<input type="text"/>	<input type="text"/>																																		
Concorso Militare	<input type="text"/>	<input type="text"/>	<input type="text"/>	<input type="text"/>	<input type="text"/>	<input type="text"/>	<input type="text"/>	<input type="text"/>	<input type="text"/>	<input type="text"/>	<input type="text"/>	<input type="text"/>	<input type="text"/>	<input type="text"/>	<input type="text"/>																																		
Concorsi Federativi																																																	
Per la classifica individuale FST occorre tirare i due tiri militari più tiro di Concorso e Tiro Principale.																																																	
Per la classifica individuale FTST occorre tirare i due tiri militari e il tiro di Concorso più Qualifica JU+VE e Concorso Cantonale di Sezione 300m, i risultati di tutte queste serie vanno inserite nel AFS in partecipanti Corso GT.																																																	
Società organizzatrici																																																	
Organizzatore del Tiro di concorso Timbro e Firma	Società di Tiratori esecutrice del corso per giovani tiratori Timbro e Firma																																																
Società Tiratori San Salvatore-Paradiso																																																	



Fogli di stand: compilazione corretta

Foglio di stand Giovani Tiratori

Corso **1** Corso **2** Anno **2022** N° **1**

Cognome, Nome

Bernasconi Pierino

N° AFS

000000

Data di nascita

23.12.2007

N° Fass

000 0000

1° Giorno di tiro, tiro d'istruzione

3 x 1 colpo, tiro d'aggiustamento, A5

3 x 3 colpi, colpo per colpo, A5 - Correzioni solo dopo

5 x 1 colpo, colpo per colpo, A5

Silberis 5/14
6.9.2019 09:53
[[236]] Legend-Meis
StJw 90 PI
0 201173(78)
1 ↘ 10:
2 ↘ 10:
3 ↘ 9
4 ↘ 9
5 ↘ 10:
6 ↘ 10
7 ↘ 9
8 ↘ 10
9 ↘ 9
10 ↘ 10
Total 96

Num cart

17

Data

Incollare la striscia

compilare a mano o
incollare qui la striscia



!

Firma del segretario

2° Giorno di tiro, tiro d'istruzione

2 x 1 colpo, tiro d'aggiustamento, A5

5 x 1 colpo, colpo per colpo, A5

1 x 3 colpi, fuoco rapido, A5

Pg 31 17/0021
18.05.19 14:18
1 ↘ 5
2 ↘ 6
3 ↘ 9
Pg 32 17/0022
18.05.19 14:22
1 ↘ 8
2 ↘ 10
3 ↘ 8
4 ↘ 7
5 ↘ 9
6 ↘ 10 52
7 ↘ 7
8 ↘ 9
9 ↘ 8
10 ↘ 8 32
T/P 8 86

Num cart

10

Data

compilare a mano o
incollare qui la striscia



!

Firma del segretario



Equipaggiamento

Portare il materiale distribuito e da scrivere per prendere appunti



 **Occhiali da vista!**



Vestirsi pesante



Soldi ed eventuali accessori



Domande





8. Istruzione al test

Sì, ci sarà un test al termine del corso





Grazie e buona serata

**Ci vediamo domani mattina alle
08:30**

Puntuali

CIAO!